

PRODUCT DESCRIPTION

Programmable transmitters and transducers with RS232 serial interface are designed to measure temperature, relative humidity and barometric pressure of air in non-aggressive environment. Transmitters and transducers are available in wall-mount and duct-mount versions or with probe on a cable. For measuring temperature and relative humidity of compressed air is used type TxxxP.

Digital conception with microprocessor allows to determine the other computed humidity values, like dew point temperature, absolute humidity, specific humidity, mixing ratio and specific enthalpy. Measured and calculated values are displayed on a two-line LCD display. Devices support Modbus RTU protocol, protocol compatible with standard Advantech-ADAM, ARION protocol and communication with HWg-Poseidon devices. For set of all parameters you can use *TSensor* software (see www.cometsystem.com)

Durable plastic case of the device contains electronics and connection terminals. For easy connection/disconnection of the output cable is used TxxxL version with Lumberg connector (IP67) instead of a cable gland.

type *	measured values	construction	mounting
T0310	T	ambient air	wall
T4311	T	external probe Pt1000/3850 ppm	wall
T2314	P	ambient air	wall
T3311	T + RH + CV	ambient air	wall
T3313	T + RH + CV	duct mount	fix by means of the gland
T3319	T + RH + CV	probe with a cable	wall
T3319P	T + RH + CV	probe with a cable - pressure up to 25 bars	wall
T7310	T + RH + P + CV	ambient air	wall
T7311	T + RH + P + CV	probe with a cable	wall

* models marked TxxxZ are custom - specified devices

T...temperature, RH...relative humidity, P...barometric pressure, CV...computed values

INSTALLATION AND OPERATION

The transmitters and transducers designed for mounting on the wall are mounted on a flat surface with two screws or bolts. The duct mount type of transmitters install by clamping a metal stem into the gland or flange PP4 or PP90 (optional accessory). The probe with a cable is placed into a measured environment. Pay attention to device mounting, because incorrect choice of working position or measuring point could adversely affect accuracy and long-term stability of measured values.

Devices are supplied with communication cable equipped with connector (TxxxL devices are supplied without cable). Another communication cable can be connected after unscrewing the four screws in the corners of case and removing the lid. Pass the cable through released upper gland and connect the wires according to diagram. The Probe Pt1000 is connected by shielded cable with a length up to 10 m. Pass the cable through released gland and connect according to diagram so that, the shielding is connected to proper terminal device only. Do not connect it to other circuitry and do not ground it. Tighten glands and screw the lid. For TxxxL devices and external probe connections is recommended to use shielded cable (external diameter 3 to 6.5 mm) with wire cross-section 0.75 mm² (TxxxL) or 1.50 mm² (external probe). All cables should be located as far as possible from potential interference sources.

Devices don't require special operation and maintenance. We recommend you periodic calibration for measurement accuracy validation.

COMMUNICATION PROTOCOLS AND ERROR STATES

Description of communication protocols you can download from www.cometsystem.cz/manuals.htm. Device setting from the manufacturer is **ModBus RTU**, address **1**, communication speed **9600 Bd** (no parity, 2 stop bits). To restore this settings, please unscrew the lid of case, close the jumper and pres the button (next to connection terminal) for longer then six seconds.

Device continuously checks its state during operation and if an error appears, it is displayed relevant code: **Err 1** – measured or calculated value is over the upper limit, **Err 2** – measured or calculated value is below the lower limit or pressure measurement error occurred, **Err 0**, **Err 3** and **Err 4** – it is a serious error, please contact distributor of the device.

SAFETY INSTRUCTIONS



- Humidity and temperature sensors of the transmitters can not be operate and store without a filter cap.
- Temperature and humidity sensors have not to be exposed to direct contact with water and other liquids.
- It is not recommended to use the humidity transmitters for long time under condensation conditions.
- Take care when unscrewing the filter cap as the sensor element could be damaged.
- Don't connect or disconnect transmitter and transducers while power supply voltage is on.
- If the sensing probe of T3319P device is installed, make sure that measured area is without pressure.
- Installation, electrical connection and commissioning should be performed by qualified personnel only.
- Devices contain electronic components, it needs to liquidate them according to currently valid conditions.
- For more information, please use detailed manuals and other documentation which are available at www.cometsystem.com

Technical specifications

Device type	T2314	T4311	T0310	T3310, T7310	T3313	T3319, T7311	T3319P
Supply voltage	9 to 30V	9 to 30V	9 to 30V	9 to 30V	9 to 30V	9 to 30V	9 to 30V
Current consumption	6 mA	6 mA	6 mA	6 mA	6 mA	6 mA	6 mA
Temperature measuring range	—	-200 to 600°C	-30 to +80°C	-30 to +80°C	-30 to +125°C	-30 to +105°C	-30 to +105°C
Accuracy of temperature measurement	—	±0.2°C (without probe)	±0.4°C	±0.4°C	±0.4°C	±0.4°C	±0.4°C
Relative humidity (RH) measuring range*	—	—	—	0 to 100%RH	0 to 100%RH	0 to 100%RH	0 to 100%RH
Accuracy of humidity measurement from 5 to 95%RH at 23°C	—	—	—	±2.5%RH	±2.5%RH	±2.5%RH	±2.5%RH
Barometric pressure measuring range	600 to 1100 hPa	—	—	±1.3 hPa (T7310)	—	600 to 1100 hPa (T7311)	—
Accuracy of barometric pressure measurement at 23°C	±1.3 hPa	—	—	—	—	±1.3 hPa (T7311)	—
Other calculated humidity variables (dew point temperature,....)	—	—	—	—	—	—	—
Recommended calibration interval	1 year	2 years	2 years	1 year	1 year	1 year	1 year
Protection class of the case with electronics	IP54	IP65	IP65	IP65 (T3311) IP54 (T7310)	IP65	IP65 (T3319) IP54 (T7311)	IP65
Protection class of the sensors cover	—	—	IP65	IP40	IP40	IP40	IP40
Temperature operating range of the case with electronics**	-30 to +80°C	-30 to +80°C	-30 to +80°C	-30 to +80°C	-30 to +80°C	-30 to +80°C	-30 to +80°C
Temperature operating range of the case with electronics**	—	—	-30 to +80°C	-30 to +80°C	-30 to +125°C	-30 to +105°C	-30 to +105°C
Temperature operating range of the sensing element (sensors)	0 to 100%RH	0 to 100%RH	0 to 100%RH	0 to 100%RH	0 to 100%RH	0 to 100%RH	0 to 100%RH
Humidity operating range	cable gland upwards	any position	cable gland upwards	cable gland upwards	cable gland upwards***	any position****	any position****
Mounting position	-30 to +80°C	-30 to +80°C	-30 to +80°C	-30 to +80°C	-30 to +80°C	-30 to +80°C	-30 to +80°C
Storage temperature range (environment without condensation)	EN 61326-1	EN 61326-1	EN 61326-1	EN 61326-1	EN 61326-1	EN 61326-1	EN 61326-1
Electromagnetic compatibility according to	140 g	150 g	150 g	160 g	240 g	220 (260, 340) g	270 (310, 390) g
Weight without communication cable (weight of the cable 70g)							
Dimensions [mm]							

Electrical wiring

Supply from a communication port

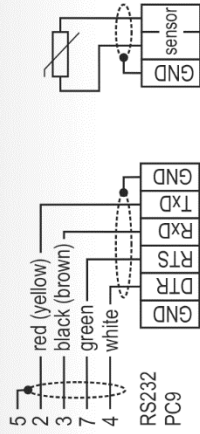

Supply from an external source

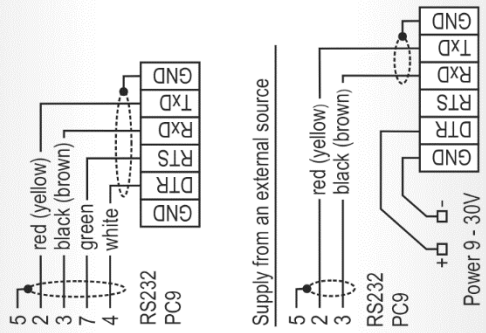

TxxxxL transmitter version, female Lumberg connection

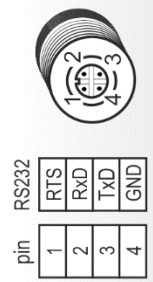

Device with cable gland

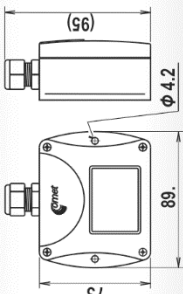

TxxxxL version of device

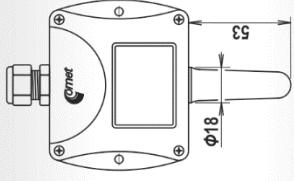
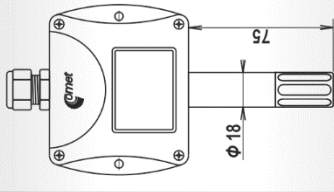
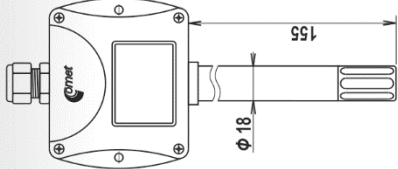
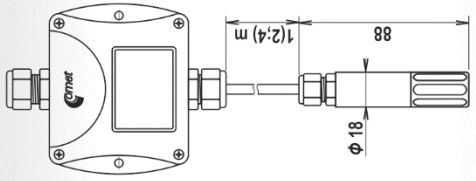
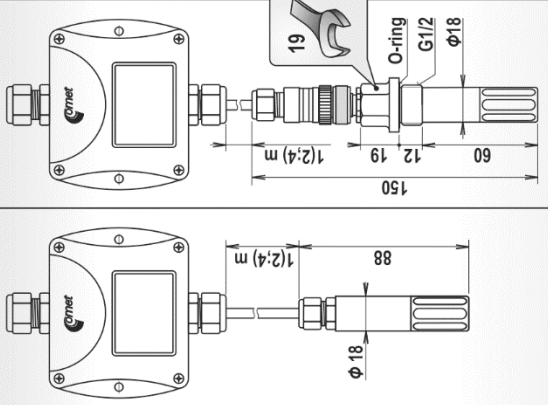
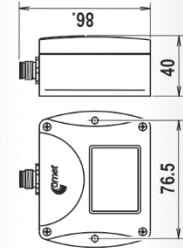

* The relative humidity measuring range is limited at temperatures above 85°C, see manuals for devices.
 ** It is recommended to switch off the LCD display at ambient temperature above 70°C.